

Diva 2 Spot

Faretto da Incasso



Soluzione perfetta
per gli armadi da cucina
vetrine e mobili.

Faretto da incasso LED super-sottile!



BK



SV



GD

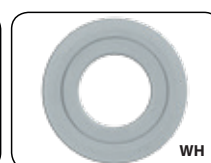

WH



Feeled Diva 2 SPOT

- Resa del colore: Ra >85
- Durata: 50.000 ore / 70%
- Temperatura d'esercizio: 0-45°C
- Efficienza energetica: 80 lm/W
- Collegabile a linee 24V DIVA2
- Disponibile in diverse finiture:
 - Silver (SV)
 - Nero (BK) su ordinazione
 - Oro (GD) su ordinazione
 - Bianco (WH) su ordinazione
- Tensione: DC 24V
- Temperatura di colore: 2700/3000/4000/6000°K
- Fascio: 60°
- Connessione estremamente facile grazie agli attacchi Snap-In
- Grado di protezione: IP 20

Connessioni ed Installazione

Collegamento fra SMPS, Diva2 Spot e Diva2 Spot



Collegamento fra SMPS, Diva2 Spot e Linee Diva2



Collegamento fra SMPS, Linee Diva2 e Diva2 Spot

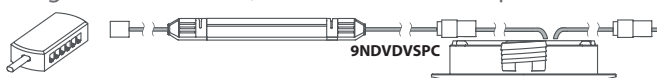

Diametro Foro

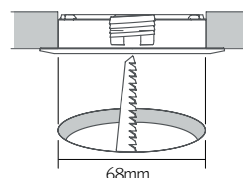

Mollette di installazione (optional)

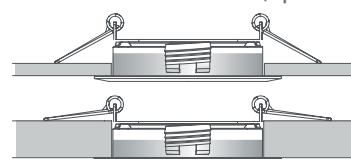

Dimensioni

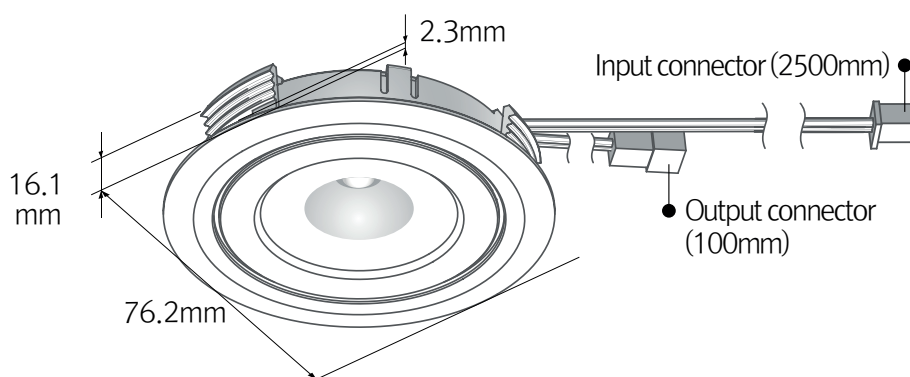

	A (mm)	B (mm)	C (mm)
SMPS 15W	121	45	16
SMPS 30W	150	41	31
SMPS 75W	180	60	32
SMPS200W	250	65	38

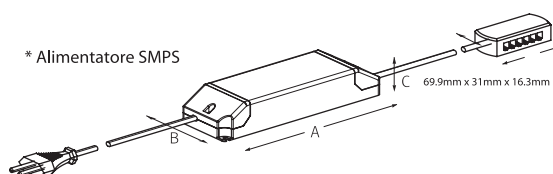

Come Ordinare

Gli elementi necessari per l'installazione delle Feeled Diva2 sono:

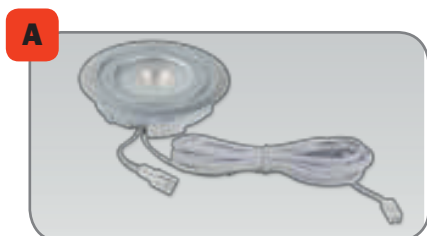

Uno o più Spot

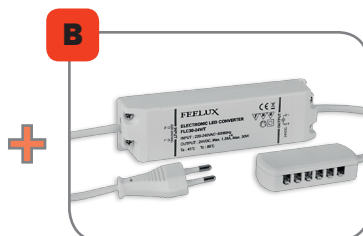

Alimentatore DC 24V

Possono essere aggiunti i seguenti accessori opzionali:

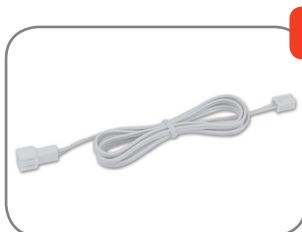

Prolunga Connessione

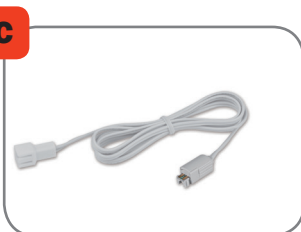

Connessione con Diva2

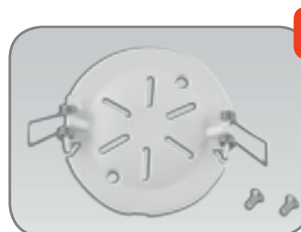

Mollette di installazione

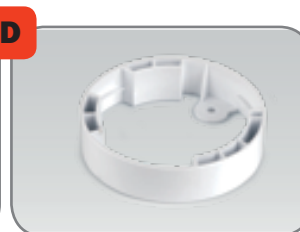

Anello per montaggio in superficie

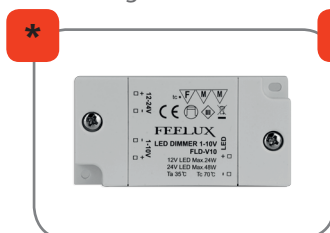

Interfacce Dimmerazione

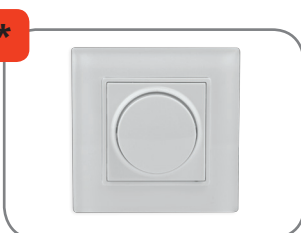

Dimmer WIRELESS

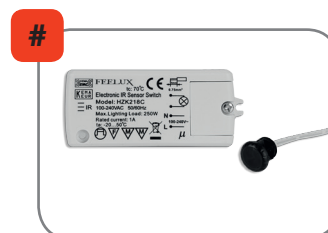

Sensori IR

Codici

Numero massimo connessioni con:

TIPO	Colore	Watt	Tonalità	9FLC15-24V/T	9FLC30-24V/T	9FLC75-24V/T	9FLC200-24V/T
A	9DVS4A30K24VSV	4	3000K	3	7	17(*)	47 (*)
	9DVS4A40K24VSV	4	4000K	3	7	17(*)	47 (*)
□	9DVS4A30K24VBK	4	3000K	3	7	17(*)	47 (*)
	9DVS4A40K24VBK	4	4000K	3	7	17(*)	47 (*)
□	9DVS4A30K24VGD	4	3000K	3	7	17(*)	47 (*)
	9DVS4A40K24VGD	4	4000K	3	7	17(*)	47 (*)
□	9DVS4A30K24VWT	4	3000K	3	7	17(*)	47 (*)
	9DVS4A40K24VWT	4	4000K	3	7	17(*)	47 (*)

(*) Max 7pz. per linea

□ disponibili su richiesta

su richiesta disponibili anche le seguenti tonalità: 2700K, 6000K

Accessori

Codice	Descrizione
B	9FLC15-24V/T SMPS-Aliment 24V Max 15W
	9FLC30-24V/T SMPS-Aliment 24V Max 30W
	9FLC75-24V/T SMPS-Aliment 24V Max 75W
	9FLC200-24V/T SMPS-Aliment 24V Max 200W
C	9DVSPTC CAVO Prolunga Alimentazione 2500mm
	9NDVPC Cavo tra DIVA2 e Diva2 Spot 2500mm
	9NDVDVSPTC Cavo tra Diva2 SPot e Diva 2 1000mm
D	9DVSSPRING MOLLETTE DI INSTALLAZIONE
	9DVSBSPRING BACK COVER CON MOLLETTE DI INST.
	9DVSMR-WT ANELLO BIANCO
	9DVSMR-BK ANELLO NERO
	9DVSMR-GD ANELLO ORO
9DVSMR-SV ANELLO SILVER	

Accessori opzionali

*	9FLD-V10	Interfaccia dimmer. 24V 1-10V max 48W
	9FDC-L10	Interfaccia dimmer. 24V 1-10V max 100W
	9FDA-L2M0	Interfaccia dimmer. 24V 0/1-10V, DMX2CH max 200W
	9FDA-L5M	Interfaccia dimmer. 24V DMX5CH max 200W
#	9FRWDIM	Controller RF a rotella
	9FRW-L4M	RF Receiver 4CH Max 180W/ch
	9FLS-M24V	Sensore IR di movimento/per PORTA
	9FLS-P24V	Sensore IR di PRESENZA UMANA

Accessori 110 Volt UL

Codice	Descrizione
B	9FLC15-24V/XL SMPS-Aliment 24V Max 15W UL
	9FLC30-24V/XL SMPS-Aliment 24V Max 30W UL
	9FLC75-24V/XL SMPS-Aliment 24V Max 75W UL

